

Lada Niva 1600

Maintenance Manual

For VAZ 2121 21212 cars



This manual comprises pages 27 to 64 of the official car manual which is not copyright. The manual is intended for owners of Lada Nivas who were not provided with a manual for their car. This manual may not be sold for profit.

This is the first version of this manual to be placed on the web. It probably contains minor spelling errors. Names of oils and grease types will shortly be printed in Russian characters. Appendixes are not yet included. Currently underway is the Operations manual for the Lada Niva which contains driving instructions for the car and how to use things such as heaters, windows, seats, mirrors and so on. It has been delayed due to the demand for maintenance information.

Important note: This manual has been designed to print on a HP-600 printer. Due to differences in printer types page alignments may vary. Print-Preview the document before printing and adjust margins as necessary to avoid blank pages.

Please send corrections or comments to jason.chapman@usa.net

Table of Contents

MAINTENANCE	3
ENGINE LUBRICATION	3
<i>Oil Sump</i>	3
<i>Oil Filter</i>	3
VALVE GEAR	4
<i>Valve Clearances</i>	4
<i>Tensioning the Valve Gear Chain</i>	5
FUEL SYSTEM	5
<i>Air Cleaner</i>	5
<i>Carburettor</i>	6
<i>Idling speed adjustment</i>	6
CRANKCASE BREATHING SYSTEM	7
COOLING SYSTEM	7
<i>Coolant</i>	7
COOLING SYSTEM THERMOSTAT	8
ALTERNATOR DRIVE BELT	8
IGNITION SYSTEM	9
<i>Ignition Distributor</i>	9
SPARK PLUGS	10
TRANSMISSION	10
<i>Clutch Fluid Reservoir</i>	10
ADJUSTING THE CLUTCH CONTROL MECHANISM	10
GEARBOX, TRANSFER CASE	11
<i>Front and Rear Axles</i>	11
<i>Propeller Shaft Splined Connections and Crosses</i>	11
<i>Joints of Front Wheel Drive Propeller Shafts</i>	11
HYDRAULIC SHOCK ABSORBERS AND ANTIROLL BAR	11
STEERING GEAR AND WHEELS	11
<i>Steering Gear Clearances</i>	11
<i>Front Wheel Hub Bearings</i>	12
<i>Examining the Front Suspension Ball Supports and Steering Rod joints</i>	14
<i>Tyres</i>	14
<i>Replacing the Wheels</i>	15
<i>Front-End Alignment</i>	15
BRAKES	16
<i>Brake Hydraulic System</i>	16
<i>Brake Fluid Reservoir</i>	17
<i>Flexible brake hoses</i>	17
FRONT BRAKES	17
REAR BRAKES	19
<i>Bleeding the Brake System</i>	20
<i>Adjusting the Free Travel of Brake Pedal</i>	21
<i>Brake Vacuum Booster</i>	21
<i>Parking Brake</i>	21
ELECTRICAL EQUIPMENT	21
<i>Wiring diagram</i>	22
<i>Storage Battery</i>	23
<i>Alternator</i>	23
<i>Starter</i>	23
<i>Voltage Regulator</i>	24
<i>Aiming the Headlight Lower Beam</i>	24
<i>Replacing the Bulbs</i>	24
<i>Tail lights</i>	25
<i>Fuses</i>	25
<i>Fuse-Protected Circuits</i>	25
BODY	26
<i>Care of Body</i>	26
<i>Windshield and Headlight Washers</i>	27

<i>Windshield and Headlight Wipers</i>	28
<i>Fastening of Units and Mechanisms to Car Body</i>	28
MAINTENINCE IN LONG-TERM STORIGE.....	28



MAINTENANCE

The mechanisms, units and parts subject to scheduled maintenance are indicated by reference numbers in Figs 25 and 26. Table 1 contains the lubricating instructions and Table 2, maintenance instructions (cleaning, checking and adjustment).

The car should be serviced every 10,000 Km. However, during the initial period of operation, when working-in of all the units and mechanisms takes place, the car should be serviced after covering the first 2,000-3,000 Km. This will ensure superb performance and long service life of the car.

The list of the tools and accessories delivered with the car for Owner's services is given in Appendix 3.

ENGINE LUBRICATION

Oil Sump

Every 500 Km check the oil level in a cold engine and add oil, if necessary. The oil level should be between marks MIN and MAX on oil dipstick 1 (Fig. 27).

On a new engine change oil after the first 2,000-3,000 Km, then at 10,000 Km and thereafter every 10,000 Km. Change oil while the engine is still hot. Drain used oil after removing the plug of the hole in the bottom of the engine sump. Pour fresh oil through oil filler neck 2, located on the cylinder head cover.

The seasonal change of oil depends on the change of season as different temperature conditions call for the employment of different grades of oil (see Appendix 2).

Every 30,000 Km wash the lubricating system. Wash the system earlier only when sticky gum deposits accumulate on the camshaft housing.

Perform this operation on a hot engine as follows:

- Drain used oil from the engine sump.
- Fill the engine with a special detergent oil, to the MIN mark and let the engine run idle at a speed of about 1,000 rpm for 10 minutes.
- Drain the detergent oil, replace the oil filter and pour in fresh oil of the grade recommended for the season.

note. When using equivalent oils produced by different firms, wash the lubricating system each time before the oil change.

Oil Filter

Every 10,000 Km replace the filter. Do it after the first 2,000-3,000 Km on a new car. To replace the filter unscrew it from the cylinder block (fig. 28). Screw the new filter in place only hand-tight.

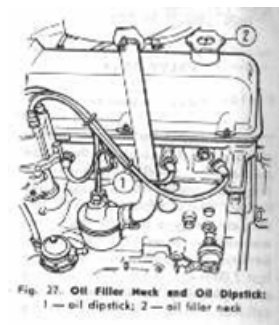

Fig. 27. Oil Filler Neck and Oil Dipstick:
1 — oil dipstick; 2 — oil filler neck



Fig. 28. Oil Filter

VALVE GEAR

Valve Clearances

Every 10.000 Km and also in case of abnormal knocking in the valve mechanism, check clearances A (Fig. 29) between the cams and valve rockers which should be 0.15 mm on a cold engine both for the intake and exhaust valves. On a new engine perform this operation after the first 2,000-3,000 Km upon checking and tightening the fasteners of the cylinder head, camshaft bearing housing and intake and exhaust manifolds.

Loosen the cylinder head bolts preliminarily through about 30" each and then tighten them according to the sequence shown in fig. 30.

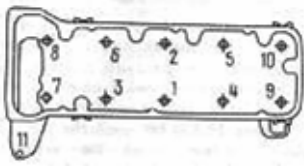
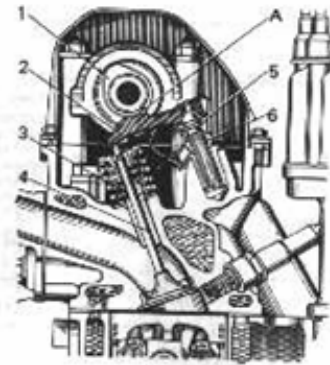

Figure 30 - Sequence of tightening cylinder head bolts

Tighten bolts 1 through 10 to a torque of 115 N·m (11.5 kg · m), and bolt 11 to a torque of 38 N·m (3.8 kg · m).

Tighten the nuts of the camshaft bearing housing by applying a torque of 22 N·m (2.2 kg m) according to the sequence shown in fig. 31.



Valve Gear

A - Valve rocker to cam clearance 1 - cam, 2 - valve rocker, 3 - valve oil deflecting cap, 4 - valve, 5 - rocker adjusting bolt, 6 - adjust bolt locknut.

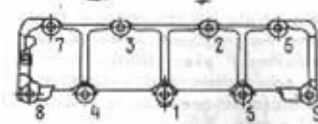

Fig 31. Sequence of tightening camshaft bearing housing nuts

To adjust the valve clearances, proceed as follows:

- Remove the cylinder head cover with its gasket; if necessary, first remove the heater air intake box;
- Rotate the crankshaft clockwise to align mark A (Fig. 32) on the sprocket with mark B on the camshaft housing; in this case the piston of the No. 4 cylinder will be on TDC at the end of the compression stroke, and both valves will be closed
- Adjust the rocker-to-cam clearances of the exhaust valve on the No. 4 cylinder (8th cam) and of the intake valve on the No. 3 cylinder (6th cam); for this purpose, loosen locknut 2 (Fig. 33) and rotate adjusting bolt 1 to set the required clearance, using a flat feeler gauge inserted between the cam and the rocker (the feeler gauge should move in this case with a slight biting)
- Holding bolt 1 in this position with a wrench, tighten locknut 2 by applying a torque of 52 N·m (5.2 kg · m) and recheck the clearance
- Turning the crankshaft each time through half a revolution, adjust the clearances of other valves, following the sequence given in Table 3 below.

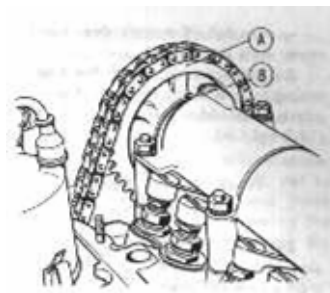

Fig 32. Setting No. 4 Cylinder piston in TDC

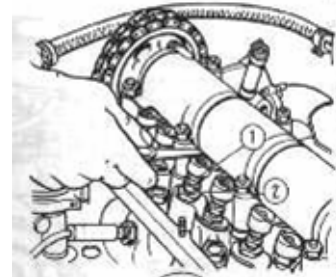

Fig 33. Adjusting valve clearances: 1- adjusting bolt, 2- adjusting bolt locknut

Table 3 - Sequence of Valve Clearance Adjustment.

Crankshaft angle degrees	No of cylinder in which piston is on TDC at end of compression stroke	Valves under adjustment			
		exhaust		intake	
		Cylinder No.	Cam No.	Cylinder No.	Cam No.
0	4	4	8	3	6
180	2	2	4	4	7
360	1	1	1	2	3
560	3	3	5	1	2

- Reinstall the cylinder head cover with its gasket. Adjustment over, check the tightening torque of the crankshaft jaws, which should be 122 N·m (12.2 kg · m).

Tensioning the Valve Gear Chain

Every 10.000 Km, adjust the tension of timing chain 2 (Fig. 34). Do it on a new car after the first 2,000- 3,000 Km. For this purpose, loosen retaining nut 7 and turn the crankshaft through 1-1~5 revolutions in the direction of its normal rotation. In this case spring 10 actuates shoe 6 through plunger 11 and automatically sets the required chain tension. Adjustment over, tighten nut 7. Adjust chain tension also in case of excessive operation noise in the valve gear.

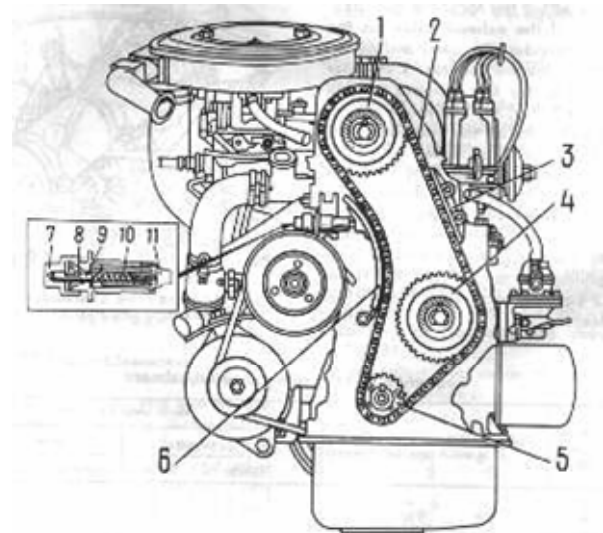

Fig 34. Valve Gear Drive. 1 - camshaft sprocket, 2 - chain, 3 - dampener, 4 - oil pump drive shaft sprocket, 5 - crankshaft sprocket, 6 - chain tensioner shoe, 7 tensioner rod retaining nut, 8 - retainer, 9 - tensioner adjusting rod, 10 - plunger spring, 11 - tensioner plunger

FUEL SYSTEM

Air Cleaner

Every 10.000 Km replace filter element 3 (Fig. 35); to this end unscrew nuts 1 and remove cover 2. When driving on extremely dusty roads, replace the filter element every 5,000 Km.

Seasonal adjustment of the air cleaner is required for delivery of fresh or warm air (warmed by the exhaust manifold). If the average ambient temperature in the season is below 15 °C, slightly pull and then shift the handle 5 of the gate on the housing of thermo-regulator 4 in the upper position (HOT) and if the average temperature is above 15 °C, shift the handle to the lower position (COLD).

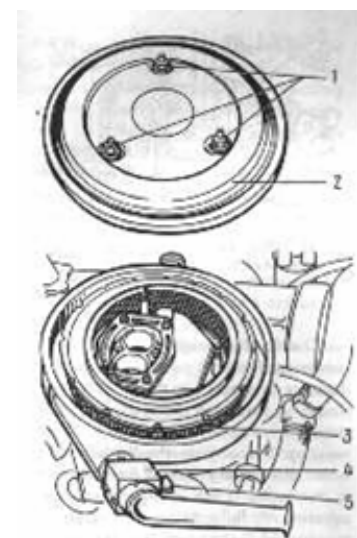

Figure 35. Air Cleaner 1- nut, 2- cover, 3- filter, 4- thermo-regulator, 5- handle

Carburettor

Every 10,000 Km (and also after the first 2,000-3,000 Km if the car is new), wash the carburettor fuel filter and the fuel pump filter with gasoline and blow them out with compressed air.

Every 20,000 Km clean the carburettor from the inside, wash it with gasoline or benzene and blow out with compressed air. When cleaning the calibrated orifices of the jets, use a wooden stick or match with a pointed end wetted with acetone. Do not use wire, even soft, not to disturb the dimensions and finish of the orifices. When screwing the jets in or out, avoid damaging the thread in the holes.

Check and, if necessary, adjust the fuel level in the float chamber and the float travel, for which purpose.

- Make sure that the mass of float 9 (Fig. 36) complete with arm 7 is 12+1 g, the float has no holes or dents, and can freely rotate on its pin.
- Make sure that seat 2 of needle valve 4 is tightened reliably and that damper ball 5 built into needle valve 4 does not stick
- Set upper body 1 vertically so that the fuel inlet union is directed upwards, the needle valve is closed, and float tongue 8 lightly contacts the needle valve ball.
- With the parts in this position, measure the distance between the float and the surface of gasket 10 which fits the upper body; the distance should be 6.5 mm
- Change the position of the tongue, if necessary, to obtain the required distance; the tongue must be perpendicular to the valve axis, and the contacting surface of the tongue should have no defects that may cause sticking of the valve.
- Check the float travel which should be 8 mm, changing the position of stop 3, if necessary.
- Check that pull-back yoke 6 of the needle valve does not interfere with free travel of the valve.
- Reinstall the carburettor upper body after making sure that the float is free to move without brushing against the chamber walls.

Note. When replacing the needle valve, also replace the gasket between the seat and the upper body.

Idling speed adjustment

Every 10,000 Km (and also after the first 2,000-3,000 Km if the car is new), adjust the minimum idling speed of the engine. Have this adjustment done at a service station. The Owner is allowed only to carry out fine adjustment of the engine idling speed within the range permitted by idle speed screw limiting bushing 1 (Fig. 37) and by idle mixture screw limiting bushing 2. Attempts to turn the bushings through a larger angle will destroy them. In this case the Manufacturer bears no responsibility for excessive content of carbon monoxide (CO) in the exhaust gases and for excessive fuel consumption.

Perform the fine adjustment with the engine warmed-up, valve clearances adjusted, and a spark advance angle set properly. Proceed as follows.

- Start the engine and turn idle mixture screw limiting bushing 2 all the way out.
- Using idle speed screw limiting bushing 1, set the engine speed within 850-900 rpm

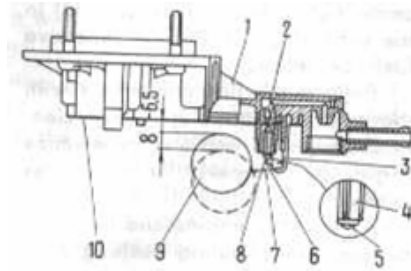

Fig. 36. Adjusting Fuel Level In Carburettor Float Chamber: 1- carburettor upper body, 2 - needle valve rest, 3 - stop, 4 - needle valve, 5- ball, 6- pull-back yoke, 7—arm, 8—lounge, 9- float, 10- gasket.

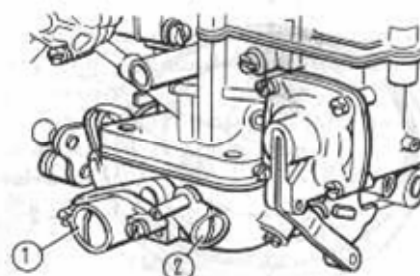

Fig 37. Idling system adjustment screws: 1- Idle speed screw limiting bushing, 2- idle mixture screw limiting bushing.

Check the engine idling performance. For this purpose, abruptly depress and release the accelerator pedal; in this case the engine speed should increase smoothly without missing. The engine should not stall when the idling speed is reduced to minimum. If the idling speed fine adjustment fails to ensure normal running of the engine without missing, apply to a service station for a qualified help.

CRANKCASE BREATHING SYSTEM

Every 20.000 Km clean and wash with gasoline the hoses of the crank- case breathing system, the shut-off valve on the carburettor throttle valve shaft, and the flame arrester located in the exhaust hose running from the engine to the air cleaner.

COOLING SYSTEM

Coolant

The cooling system of the cars leaving the plant is filled with special fluid A-40M. This fluid is an ethylene glycol mixture with a freezing point of minus 40°C and anticorrosive, antifoaming and antiscaling properties. It needs no replacement within a period of three years. Therefore, care of the cooling system during this period consists only in checking at regular intervals the fluid level in the expansion tank.

The fluid level should always be 3-4 cm above the MIN mark (Fig. 38). Check the fluid level on a cold engine only, since when the engine is hot the level may rise significantly; expansion of the fluid volume may also take place immediately after engine shutdown.

If the fluid level is below the MIN mark, replenish the expansion tank with fluid of the same grade. If the coolant level drops constantly and frequent replenishments are required, check the cooling system for leakage and eliminate the trouble. In an emergency the cooling system may be filled with clean water. In this case proceed as follows:

- Cool the engine.
- Remove the caps from the radiator and expansion tank.
- Pour water into the radiator (keep pouring water until it starts flowing out of the radiator filler neck).
- Reinstall the radiator cap.
- Add water into the expansion tank until its level is 3-4 cm above the MIN mark.
- Reinstall the expansion tank cap.

In cold seasons if water has been added into the cooling system and before placing the car in motion, warm the engine up to 85-90°C to make the fluids mix. Bear in mind that water added into the cooling system raises the freezing temperature of the mixture; therefore, perform the necessary repairs of the cooling system at the first opportunity and fill it with the coolant of the prescribed grade.



Fig 38 Cooling system expansion tank

Every three years or every 60,000 Km (whichever comes first), flush the cooling system and fill it with fresh coolant.

Drain coolant from the system through two drain holes 1 and 2 (Fig. 39), one of which is located in the radiator bottom tank and the other one in the cylinder block at the left side. In doing so shift the heater cock control lever to the right most position.

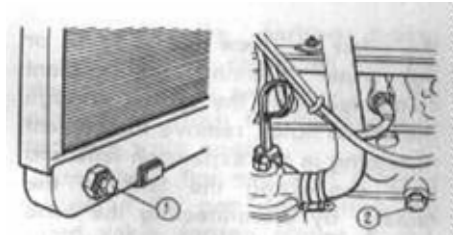

Fig 39. Cooling system drain holes. 1- drain hole in radiator bottom, 2- drain hole in cylinder block.

For screwing the radiator drain hole plug in or out, use two wrenches; one to keep in place the plug union soldered into the radiator tank, and the other to screw the plug in or out. After draining the coolant completely from the system through the above holes, remove the coolant remaining in the expansion tank and hose connecting the tank to the radiator by disconnecting the hose from the expansion tank or by raising the tank proper to a required height.

To flush the cooling system, proceed as follows.

- Fill the system with clean water, start the engine and run it until the bottom tank of the radiator gets warmed and, with the engine idling, drain water through the radiator and cylinder block drain holes.
- Let the engine cool down, refill the system with clean water and repeat the above operation.

After the flushing pour coolant into the cooling system. If the coolant of the specified grade is not available, it is permissible (at ambient temperatures above zero) to use clean water, as soft as possible to avoid heavy scale deposition which leads to engine overheating under normal operating conditions. When using hard water, flush the cooling system twice a year with special descaling agents.

If an aluminium radiator is installed in the car do not use water in the cooling system as water affects corrosion resistance of the radiator.

Cooling System Thermostat

Every 20.000 Km and also in case of abnormal temperature of the engine (overheating under normal operating conditions or excessively long warm-up period after starting), check thermostat 4 (Fig. 40) for normal functioning. A simple check is the hand- feeling of the thermostat directly on the car. Upon starting the cold engine with the thermostat serviceable, the bottom tank of the radiator starts getting warm as soon as the coolant temperature is 80-85 °C.

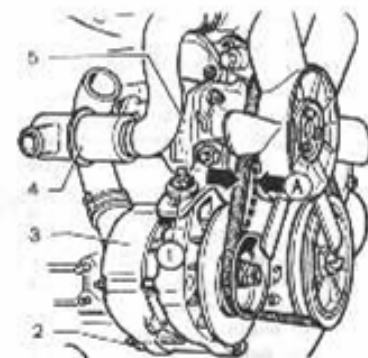

Fig 40. Checking tension of Alternator drive belt. 1- nut, 2- nut of alternator joint pin, 3- alternator, 4- thermostat, 5- water pump, A- belt deflection.

Alternator Drive Belt

Every 10.000 Km (and after the first 2,000-3,000 Km if the car is new), check the belt for tension. Normal deflection A (Fig. 40) is 10-15 mm if a force of 100 N (10 kg) is applied.

To increase the belt tension, proceed as follows.

- Loosen nut 1 that fastens the alternator to the adjusting arm.
- Loosen nut 2 of the alternator joint pin.
- Shift alternator 3 away from the engine and tighten the fastening nuts.

Avoid over tightening the belt so as not to overload the bearings of alternator 3 and water pump 5.

IGNITION SYSTEM

Ignition Distributor

Every 10,000 Km:

1. Check the working surfaces of breaker contacts 3 (Fig. 41). In case of heavy transfer of metal from one contact point to the other, dress them with a flat barette file. Do not eliminate completely the crater on the breaker arm contact point. Check and, if necessary, dress the contacts in the distributor cap and on the rotor.
2. Use a piece of clean, gasoline- soaked chamois leather or some other lint-free material to clean the breaker contact points, the rotor, and the outer and inner surfaces of the distributor cap.
3. Check the breaker point gap which should be $0.4+0.05$ mm, for which purpose.
 - Shift the gearshift lever into the neutral.
 - Apply the parking brake;
 - Rotate the crankshaft with the starting crank to set cam 15 in the position at which the breaker contacts are wide open.
 - Check the gap with a feeler gauge; if the gap differs from the rated value, loosen screws 4 and, using a screwdriver inserted into special slot 5, shift the breaker contact post as required; adjustment eve, tighten screws 4.
4. Check ignition timing, for which purpose
 - Connect one end of the wire of a 12-V test lamp to terminal 6, and ground its other end.
 - Turn on the ignition and slowly rotate the crankshaft with the starting crank; with the ignition set properly, the test lamp should come on when mark 4 (Fig. 42) on the crankshaft pulley is aligned with mark 2 on the timing gear cover, and the contact of rotor 2 (Fig. 41) should be opposite the contact of the No. 1 cylinder on the distributor cap.
5. If the marks are not aligned at the moment the test lamp comes on, adjust the ignition timing as follows.
 - Rotate the crankshaft with the starting crank to set it in the position at which the rotor contact faces the contact of the No. 1 cylinder on the distributor cap, and mark 4 (Fig. 42) is aligned with mark 2 (in this position the piston of the No. 1 cylinder will be 5° before TDC as measured in crankshaft degrees);
 - Loosen nut 11 (Fig. 41) and turn distributor body 12 clockwise until the breaker points are closed.
 - Slowly rotate the distributor body counter-clockwise until the test lamp comes on; in doing so, slightly press the rotor counter-clockwise to take up clearances.
 - Stop the distributor body exactly at the moment the test lamp comes on (the breaker contact points are at the beginning of opening phase).

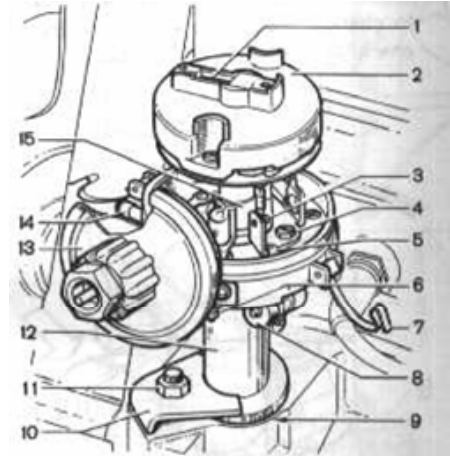

Figure 41. Ignition distributor. 1- noise resistor suppressor, 2- rotor, 3- breaker contacts, 4- screw, 5- slot, 6- terminal, 7- spring catch, 8- capacitor, 9- scale, 10- bracket, 11- nut, 12- body, 13- vacuum spark timer, 14- lubricator, 15- cam

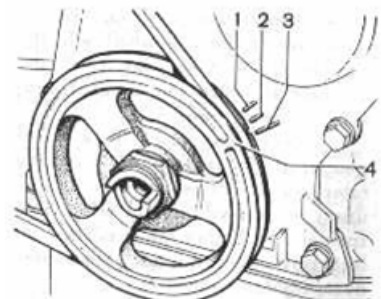

Fig 42. Timing marks on pulley and valve gear drive cover. 1- 10°, 2- 5°, 3- 0°, 4- mark on pulley

- Holding the distributor body in this position, tighten nut 11.
- Switch off the ignition, install the distributor cap on its body, and secure it with two spring catches 7.

On a new car, check the breaker point gap and ignition timing after the first 2,000-3,000 Km. Every 20,000 Km deliver 2-3 drops of engine oil into the hole of lubricator 14.

Spark Plugs

Every 10,000 Km proceed as follows:

1. Using gasoline and a stiff brush, remove carbon deposit from the spark plugs.
2. Check the spark plug gap with a round wire feeler gauge. The gap should be 0.5-0.6 mm (Fig. 43); the gap must be adjusted only by bending the side electrode.

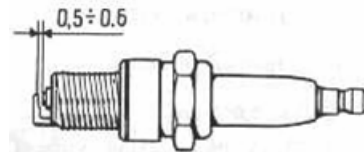

Fig 43. Checking spark plug gap

Every 20,000 Km replace the spark plugs with new ones. For reliable starting of the engine at low sub-zero temperatures, it is recommended to replace the long-used spark plugs with new ones, even if the used spark plugs are still serviceable; they can be used again in warm seasons of the year.

TRANSMISSION

Clutch Fluid Reservoir

Every 10,000 Km check fluid level in the reservoir (Fig. 44) and replenish, if necessary, to the lower edge of the filler neck.

Add HeBa (Neva) or Tomb (Tom) brake fluid only. It is recommended to change the brake fluid with fresh one after five years of service.

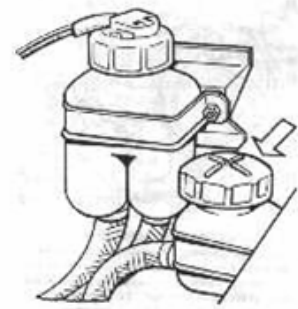

Adjusting the Clutch Control Mechanism

Every 30,000 Km (and also after the first 2,000-3,000 Km and 10,000 Km if the car is new) check and, if necessary, adjust the clutch control mechanism for which purpose.

Check clearance between pushrod 3 (Fig. 45) and piston 2 of master cylinder 1 which should be 0.1-0.5 mm. The clearance corresponds to the travel of pedal 5 through 0.4-2 mm and it is adjusted with stop 4.

Check free travel of pushrod 6 of operating cylinder 10 which should be 4-5 mm. Pushrod free travel is adjusted with nut 8 after loosening locknut 9. Adjustment over, tighten locknut 9.

Upon completion of the above adjustments free travel of the clutch pedal before the beginning of clutch release should be 25-35 mm. Check the clutch pedal free travel also after the bleeding of the hydraulic control system. Presence of air in the system is indicated by the spongy pedal and incomplete release of the clutch (clutch drags). Bleed the system through the union of operating cylinder 10 in the same way as the brake system.

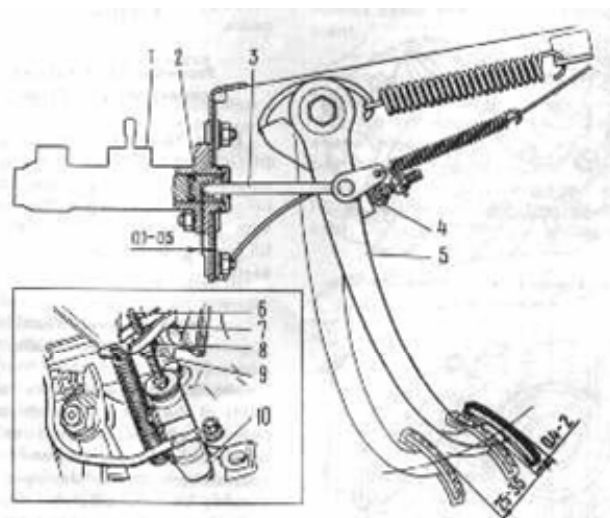

Fig 45. Adjusting Clutch control mechanism. 1- Clutch master cylinder, 2- pushrod piston, 3- pushrod, 4- pedal travel stop, 5- clutch pedal, 6- operating cylinder pushrod, 7- clutch release fork, 8- nut, 9- locknut, 10- operating cylinder.

Gearbox, Transfer Case.

Front and Rear Axles

After the first 2000-3000 Km and every 30.000 Km, change oil in the gearbox, transfer case, and front and rear axles. Do it right after the trip, when oil is still hot. Drain used oil through the holes closed with plugs 2 (Figs. 46, 47, 48, 49). Pour fresh oil through the level check holes closed with plugs 1, up to the lower edges of these holes.

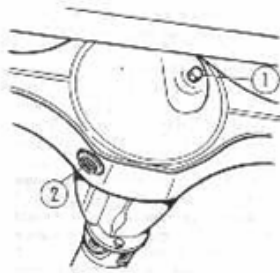

Fig 49. Rear Axle. 1- check hole plug, 2- drain hole plug.

Every 10,000 Km check oil level which should reach the lower edges of the level check holes. Check before the trip to be sure that all oil has dripped down from the walls and gears.

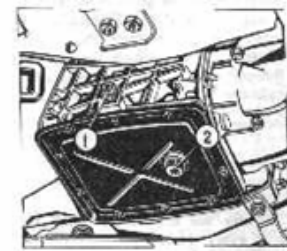

Fig 46. Gearbox. 1- check hole plug, 2- drain hole plug

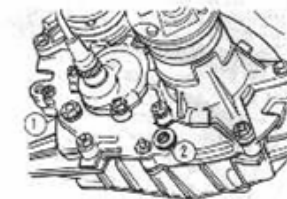

Fig 47. Transfer Case. 1- check hole plug, 2- drain hole plug

Propeller Shaft Splined Connections and Crosses

Every 10.000 Km deliver grease to the splined connections through the grease fittings and grease-gun the crosses with grease No. 158 or cDMOn-ZY till fresh grease shows up under the seals.

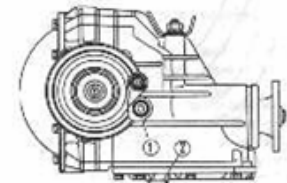

Fig 48. Front Axle. 1- check hole plug, 2- drain hole plug

Joints of Front Wheel Drive Propeller Shafts

While in service, care of the joints of the front wheel drive propeller shafts is confined only to regular checking the condition of protective boots. A damaged boot should be immediately replaced with a new one upon washing the joint and changing the grease. This operation should be performed at a service station.

HYDRAULIC SHOCK ABSORBERS AND ANTIROLL BAR

Every 30.000 Km check the shock absorbers for serviceability. If the shock absorbers operation becomes less efficient, which is manifested by slow damping of oscillations (3-4 oscillations) of the car body on crossing a road bump, or by unusual knocking in the shock absorbers, apply to a service station. Pay attention also to the condition of shock absorber rubber bushings and rubber cushions of the antiroll bar. If the rubber bushings and cushions show any signs of damage or age-hardening, replace them with new ones.

STEERING GEAR AND WHEELS

Steering Gear Clearances

Every 20,000 Km (and also after the first 2,000-3,000 Km if the car is new), check the steering wheel for play which should not exceed 18-20 mm measured on the wheel rim with the wheels in the straight ahead position and with normal clearances in the steering gear. If the steering wheel play exceeds this value, perform an overall check of the steering gear:

1. Make sure that the bearings of the front wheel hubs are adjusted properly and the tyre inflation pressure is normal.
2. Turning the steering wheel in either direction, check for knocking in the joints, steering mechanism and connections. Check and tighten, if necessary, the fastenings of the pitman arm, steering gear case, brackets of the idler arm and steering shaft.
3. Rocking the steering wheel hand-feel the steering rod ball joints for play.
4. Make sure the ball supports and the joints of the front suspension wishbones are in serviceable condition.
5. Eliminate the faults detected and check steering wheel play. If steering wheel play exceeds the permissible value, check and adjust the following clearances in the steering mechanism:

Clearance in the worm bearings that is found by axial movement of the steering shaft while turning the steering wheel leftward and rightward through a small angle; eliminate the clearance by decreasing the number of shims 3 (Fig. 50) placed between the case and the thrust bearing cover until the shaft rotates easily without axial displacement;

Roller-to-worm backlash which is found by rocking the pitman arm head, with the rods disconnected, with the car wheels in the straight ahead (neutral) position; eliminate backlash by turning in screw 1, with nut 2 loosened and the pitman arm in the neutral position; adjustment over, tighten nut 2; there should be no backlash between the roller and worm when the steering wheel is turned through 30° to the right or to the left from the neutral position.

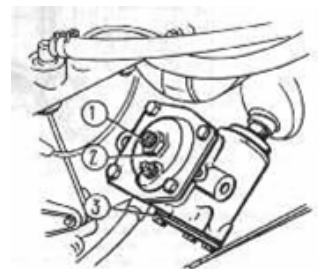

Fig 50. Adjusting clearances in steering mechanisms. 1- screw, 2- nut, 3- shims

Front Wheel Hub Bearings

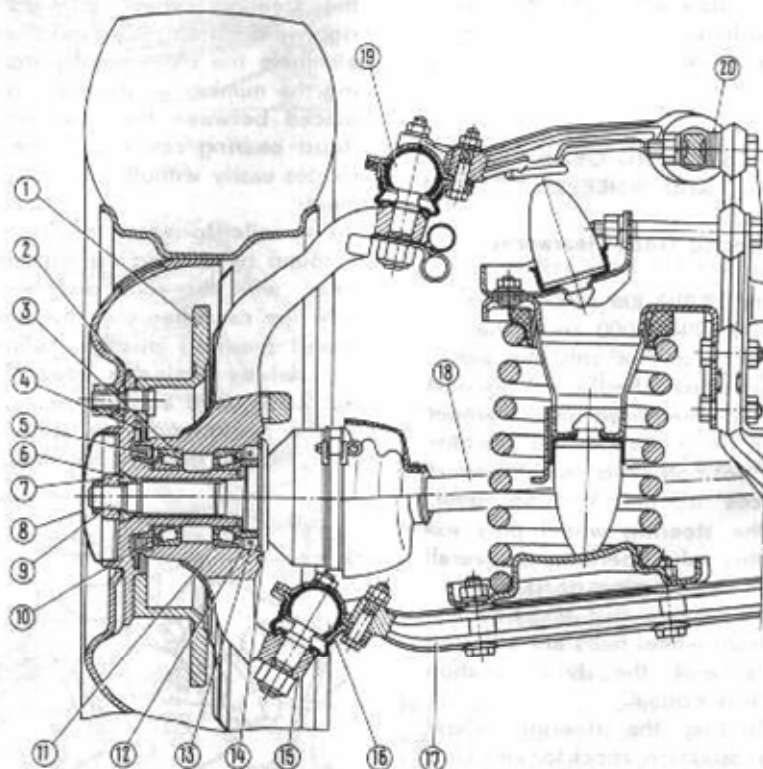

Fig. 51. Front Wheel: 1 - brake disc; 2 - hub; 3 - outer roller bearing; 4 - outer seal protective ring; 5 - outer seal; 6 - tapered bushing; 7 - hub nut; 8 - hub cap; 9 - propeller shaft drive end; 10 - outer seal demounting ring; 11 - inner roller

bearing; 12 - inner seal demounting ring; 13 - inner seal; 14 - inner real protective ring; 15 - steering knuckle; 16 - lower wishbone ball support; 17 - lower wishbone; 18-propeller shaft; 19-upper wishbone ball support; 20 - shims

Every 10.000 Km (and also after the first 2,000-3,000 Km if the car is new), check and adjust, if necessary, the clearances in the front wheel hub bearings. For this purpose, proceed as follows:

- Place the car on a level ground, apply its parking brake, loosen the wheel fastening nuts, jack up the wheel and remove it, having turned off the wheel nuts
- Remove hub cap 8 (Fig. 51), secure a device with an indicator on steering knuckle 15 so that the indicator finger contacts the end face of hub 2 near the tapered hole;
- Pull the hub to yourself by hands, and set the indicator pointer to zero;
- Measure the clearances in the hub bearings, for which purpose push the hub axially away from yourself. If in this case the indicator readings exceed 0.15 mm, adjust clearances in the bearings in the following way;
- Remove the indicator, screw off nut 7 and replace it with a new one;
- Tighten nut 7 to a torque of 20 N·m(2 kg m), rotating the hub in both directions;
- Loosen the nut and retighten it to a torque of 7 N · m (0.7 kg · m); then, screw it off through 20-25";
- Install the indicator and measure clearances in the bearings. If clearances exceed 0.07 mm, repeat the adjustment. If clearances are within 0.01-0.07 mm, fix nut 7 by staking the dents on the nut shoulder into the slots on drive end 9 of the propeller shaft.
- Remove the device with the indicator, install cap 8, fasten the wheel, jack down the car, and tighten the wheel nuts all the way home.

Every 20.000 Km. replace grease in the bearings of the front wheel hubs. For this purpose proceed as follows.

- Remove the wheel, disconnect the brake calliper from steering knuckle 15, and take it off brake disc 1;
 - Remove hub cap 8, screw off nut 7, take out tapered bushing 6 and remove hub 2 complete with brake disc 1;
 - Place a support under lower wishbone 17 and screw off the nuts securing ball support 16 to the wishbone;
 - Disconnect the shock absorber from the lower wishbone and the side steering rod from the arm of steering knuckle 15;
 - Shift propeller shaft 18 towards the front axle as far as it will go;
 - Turning steering knuckle 15 about upper wishbone ball support 19, remove the former from the propeller shaft drive end;
 - Use the puller to remove the cones of bearings 3 and 11 with demounting rings 10 and 12 and seals 5 and 13 from the steering knuckle space. Mark the bearing cones in order to reinstall the cones in their proper places during the assembly;
 - Remove the used grease and wash with kerosene the inner space of the steering knuckle, outer and inner spaces of the hub, propeller shaft drive end, and bearing cones;
 - Pack 40 g of fresh grease nHTon-24 into the bearing cages, apply a uniform layer of grease to the steering knuckle spaces between the bearings, and lubricate the splines of the propeller shaft drive end;
 - Reinstall the bearing cones and demounting rings, and press- fit the seals;
 - Mount the steering knuckle on the propeller shaft drive end, connect the ball support to the lower wishbone, secure the shock absorber, and connect the side steering rod to the steering knuckle arm;
 - Install the hub complete with the brake disc on the propeller shaft drive end, and install tapered bushing 6; screw on new hub nut 7 and adjust bearing clearances, as described above;
-

- Fit the hub cap, remove the support, install and secure the brake calliper, and reinstall the wheel.
- If the car is frequently driven on bad roads (deep mud), change grease every 10,000 Km.

Examining the Front Suspension Ball Supports and Steering Rod joints

If tyre inflation pressure and clearance in the front wheel hub bearings correspond to the rated values, the joints of the front wheel suspension wishbones are in good condition, the pitman arm, steering gear case, idler arm brackets and steering shaft are fastened securely, but adjustment of the steering gear fails to ensure normal play of the steering wheel, check the following:

1. Clearances in the ball supports. Check the clearances by rocking the hub with the front wheel suspension jacked up and wheels braked (to exclude the effect of clearances in the hub bearings). If the steering knuckle displacement at the level of the ball pin sphere relative to the wishbones exceeds 0.8 mm, replace the ball support.

2. Clearances in the steering rod joints. Determine the clearances by the method of mutual displacement of the steering rods when turning the steering wheel.

Premature wear of the ball joints is generally caused by damaged protective rubber boots which allow ingress of water and dust into the joints. If the boot is in good condition, the service life of the joints is practically unlimited. Therefore, check the protective rubber boots for condition at regular intervals, and replace them with new ones even if the slightest damage is detected, after making sure that the ball joints are serviceable and that there is enough grease U1P6-4in

Tyres

Every 100 Km use a tyre pressure gauge to check tyre inflation pressure, including the spare wheel. It is advisable to have the pressure gauge periodically checked at a service station. Whenever tyre inflation pressure is checked, check the tube valve for air leaks (best of all it may be done by applying soap suds to the valve inlet hole). In case of air leak- age (indicates by air bubbles) tighten the tube valve core with the valve cap, or replace it with a new one. If the valve core is in good condition, but-the tyre gets constantly deflated, demount the tyre, check and repair the tube, or replace it with a new one.

Prior to demounting the tyre, use a piece of chalk to make a mark on the tyre casing opposite the tube valve with a view to mount the tyre in compliance with this mark. This is necessary to preserve wheel balance. Demount the tyre from the wheel disc with the tyre tube deflated completely; see to it that the part of the casing opposite to the zone being demounted is in the wheel rim well. Use tyre irons for the de- mounting/mounting jobs. The di- stance between the tyre irons when catching the tyre bead should not exceed 150 mm.

Upon installation of new tyres, be sure to check the wheel balance at a service station. It is not advisable to drive the car on new tyres at a speed greater than 100 km/h during the first 500 Km.

Every 10.000 Km interchange the wheels as shown in Fig. 52 to ensure uniform wear of tyres. If abnormal vibrations in motion are detected, check wheel balance.

Replacing the Wheels

To replace a wheel, proceed as follows:

Place the car on a level ground and apply the parking brake;

Prepare the jack, tyre pump, tools bag and spare wheel;

Use the combination wrench to slacken the wheel nuts one revolution;

Insert the jack arm into the socket nearest to the wheel being replaced (Fig. 53), and rotate the jack handle until the wheel clears the ground (the jack should not sink in the ground when the car is being raised);

Unscrew the wheel nuts and remove the wheel. Install the spare wheel and uniformly tighten the wheel nuts;

Lower the car onto the wheels, and withdraw the jack;

Tighten the nuts to a torque of 70-90 N·m (7-9 kg m), check tyre inflation pressure and bring it to normal;

Stow the tools and the spare wheel under the hood, and secure them as shown in Fig. 54.

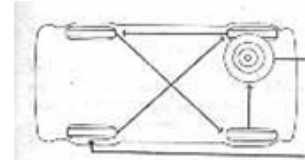

Fig 52. Wheel rotation diagram



Fig 53. Jacking up car for replacement of wheels.

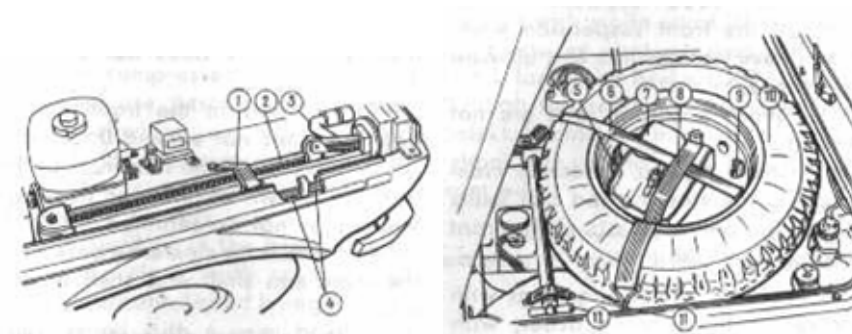

Fig 54. Stowage and fastening of tools and accessories. 1, 6, 8, 11- elastic straps, 2- jack, 3- starting crank, 4- tyre irons, 5- inspection lamp, 7- tools bag, 9- wing nut, 10 spare wheel, 12 air pump

Front-End Alignment

Every 20,000 Km (and also after the first 2,000-3,000 Km if the car is new) as well as in case of rapid and irregular wear of the front wheel tyres and impaired steering of the car, check the front-end alignment. It is advisable that this operation is performed at a service station equipped with a precision optical stand ensuring high-accuracy checking and front-end alignment. Given below is a method, though less accurate, of checking only the wheel camber and toe-in by the Owner himself, on condition that the following requirements are met:

Tyre inflation pressure is normal;

Radial and axial runout of the front wheel rims does not exceed 3 mm;

End play in the front wheel bearings does not exceed 0.15 mm;

Backlash in the steering worm- to-roller mesh ensures a steering wheel play not exceeding 5"; there is no clearance between the idler arm shaft and shaft bushings;

The rubber elements in the joints of the front suspension wish- bones have no ruptures and ultimate distortions;

Shock absorber rods are not jamming; there are no excessive clearances in the steering rod ball joints and in the ball supports of the front suspension wishbones.

Check the wheel alignment with the car in the running order, with a load of 3,200 N (320 kg) which roughly corresponds to the weight of four persons plus 400 N (40 kg) of luggage in the luggage compartment. Place the car on a flat level ground and set the front wheels in the position that corresponds to the straight-ahead motion.

To stabilise the position of the suspension units, exert pressure on them by pushing down first the rear and then the front bumpers for 2-3 times, applying a force of about 400-500 N (40-50 kg). To determine wheel camber, measure distance C (Fig. 55) between the wheel rim and the set square. Then roll the car to turn the wheels through 180°, and measure distance D. Camber is correct if distance D is 1-5 mm greater than distance C. Camber is adjusted by changing the number of shims 20 (Fig. 51) between the upper wishbone shaft and the cross member. Check and adjust toe-in only after checking and adjusting the wheel camber.

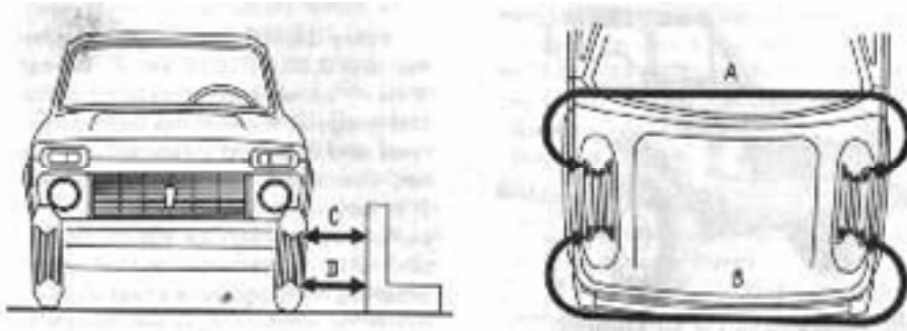

Fig 55. Checking front end alignment

To determine toe-in, measure distance A (Fig. 55) between the corresponding points on the front wheel rims. Then roll the car to turn its wheels through 180° and measure distance B. Toe-in is correct, if the first dimension is 2-4 mm greater than the second one.

Camber is adjusted by changing the number of shims 20 (Fig. 51) between the upper wishbone shaft and the cross member.

Check and adjust toe-in, measure distance A (Fig. 55) between the corresponding points on the front wheel rims. Then roll the car to turn its wheels through 180 degrees and measure distance B. Toe-in is correct, if the first dimension is 2-4 mm greater than the second one.

Toe-in is adjusted by changing the length of side steering rods 3 (Fig. 56). For this purpose loosen clamps 2 and turn adjusting sleeves 1 through the same number of revolutions in the opposite directions, thus screwing the sleeves on or off and changing the length of the side steering rods. Adjustment over, tighten clamps 2 to a torque of 19 N · m (1.9 kg · m) so that their slots face down and their ends, after tightening, do not touch each other.

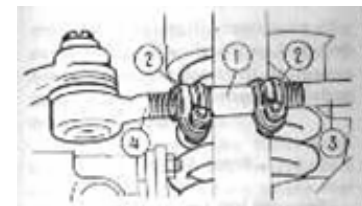

Fig 56. Adjusting length of side steering rods. 1- sleeve, 2- clamps, 3- side steering rod, 4- steering rod end.

Camber and toe-in can be also checked and adjusted, though less accurately, with the car unloaded. In this case wheel camber D-C should be from -1 to +3 mm, and toe-in A-B should be 4~1 mm.

BRAKES

Brake Hydraulic System

The brake system of the car is given in Fig. 57. Prior to servicing the brake system, clean each brake of dirt, wash it with warm water and dry with compressed air.

Never use gasoline, diesel fuel, trichloroethylene or other mineral solvents for the purpose since they attack the cups and seals of the hydraulic cylinders.

The surfaces of the brake linings should be clean, with no traces of dirt or lubricant. Soiled linings should be cleaned with a wire brush and washed with white spirit. If the pads or linings are contaminated with oil, check for oil or brake fluid leakage through the seals and eliminate the defect. During the maintenance operations take care to protect the brakes from oil.

If free travel of the brake pedal exceeds 5 mm with the engine stopped, or the braking efficiency of the wheels becomes different, perform an all-round check of the brake system.

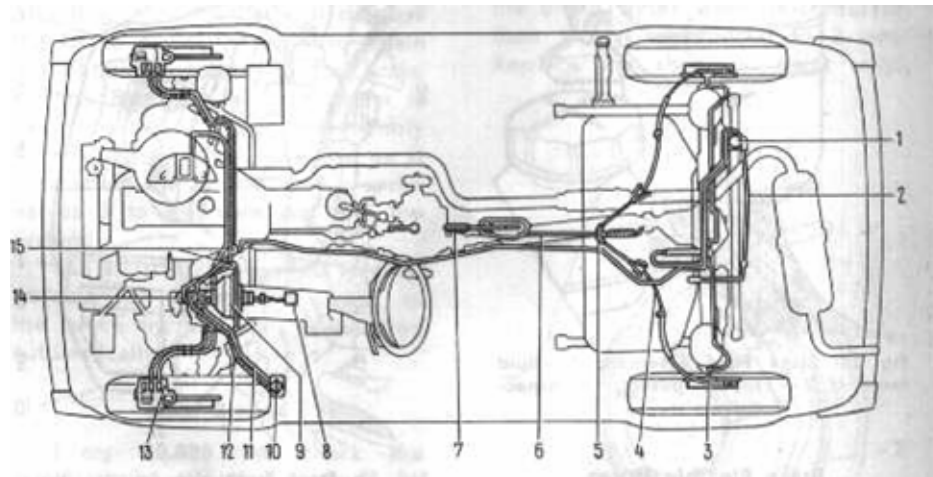

Fig. 57. Brake System Diagram: 1 - pressure regulator; 2 - pressure regulator torsion lever; 3 - rear brake wheel cylinder; 4 - parking brake rear cable; 5 - rear cable equaliser; 6 - parking brake front cable; 7 - parking brake lever; 8 - brake pedal; 9 - vacuum booster; 10 - brake fluid reservoir; 11 - primary brake circuit; 12 - secondary brake circuit; 13 - (rent disc brake cylinder block; 14 - brake master cylinder; (5 - T-piece

Brake Fluid Reservoir

Every 10,000 Km check the fluid level in reservoir 1 (Fig. 58), which should be as high as the lower edge of the filler neck with cap 2 installed. Add only brake fluid Hesa or ToML. Depress pusher 3 on the reservoir cap to check the fluid level transmitter for proper functioning; with the ignition switched on the warning lamp should be constantly alight. It is recommended to replace the brake fluid after 5 years of operation.

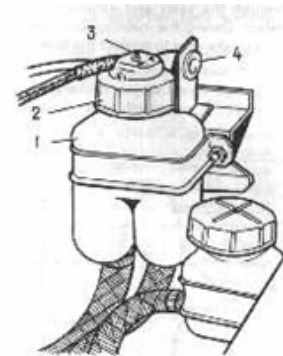

Fig 58. Brake fluid reservoir. 1- fluid reservoir, 2- cap, 3- pusher, 4- inspection lamp socket

Flexible brake hoses

Every 10,000 Km, starting from 30,000 Km check condition of the brake hoses and replace them with new ones, if minor cracks are detected on the sheathing or bulges appear on the hose when the brake pedal is pressed.

Front Brakes

Every 10.000 Km check the condition of brake shoes 6 (Fig. 59). To remove the brake shoes take out cotter pin 8 in the brake upper part; holding pressure lever 10, take out axle 7 and remove the lever; shift upwards calliper 4 complete with cylinder block 1 until the lower pressure lever is released, and remove the calliper with the cylinder block from the brake disc.

Replace the brake shoes if thickness of the friction pads is reduced to 1.5 mm. If the brake shoes are removed for purposes other than replacement, mark them to reinstall the shoes in their places.

Before installation of the brake shoes, make sure that brake disc 5 is not damaged nor deeply scored. Replace the disc if it is worn to a thickness below 9.5 mm.

To install the brake shoes push the pistons as deep into the cylinders as possible. When doing so see that the protective rubber seals of the pistons are in their sockets and are not damaged; replace the seals, if necessary.

When the pistons are pushed into the cylinders, the brake fluid level in the reservoir rises. To prevent overflowing, remove the reservoir cap and timely remove the required amount of fluid from the reservoir.

Then install brake shoes 6, fit the calliper complete with the cylinder block, and fix it with the pressure levers; for this purpose press off the lower lever and shift the calliper so that it is pressed by the lower lever; install the upper lever, insert axle 7 and fit cotter pin 8.

Upon the installation of the brake shoes the brake system needs no bleeding. It is sufficient to depress the brake pedal in order to attain the normal operation of the brake system. Bleeding of the system is necessary only after disassembly of the cylinder block, or when air is trapped in the system; use bleeder valves 3 to evacuate air from the system.

The adjustment required to compensate for the natural wear of the brake friction pads is effected automatically.

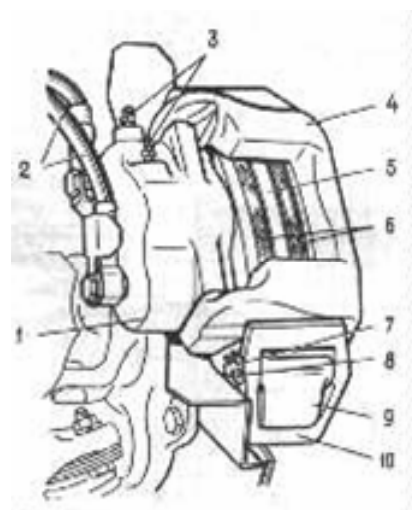

Fig 59 front brake. 1- cylinder block, 2- flexible hoses, 3- bleeder valves, 4- calliper, 5- brake disc, 6- brake shoes, 7- pressure lever axle, 8- cotter pin, 9- brake shoe guide, 10 pressure lever.

Rear Brakes

Every 20.000 Km check the condition of the brake shoes for which purpose unscrew two bolts 1 (Fig. 60), insert them into holes A and screw them in until brake drum 2 is moved off its place.

Check the condition of brake shoes 2 (Fig. 61) with friction linings 1 and inspect the working surface of the brake drum.

If the brake shoes are broken or distorted which prevents uniform shoe-to-drum contact and reduces efficiency of braking, replace the shoes with new ones. Also replace the brake shoes when thickness of their linings is reduced to 2 mm. Replace the shoes in pairs only.

If deep notches are formed on the drum working surface, have the drums turned in a lathe and ground. Prior to installing the drum, coat the mounting surface with a thin layer of graphite grease.

Adjust the shoe-to-drum clearance as follows:

- Depress the brake pedal until the shoes contact the drum;
- Keeping the shoes pressed to the drums, turn adjusting eccentric heads 1 (Fig. 62) until they contact the shoes; release the brake pedal and turn the heads in the opposite direction through approximately 10";
- Sharply depress the brake pedal 3-4 times and, having released it, check the brake drum; if it is jammed, repeat the adjustment.

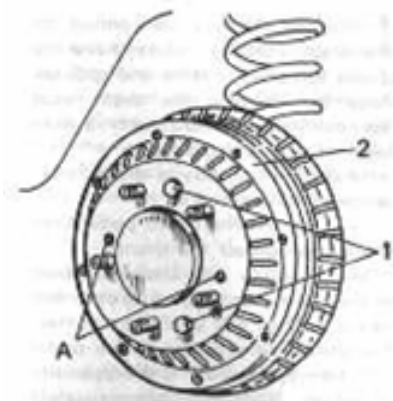

Fig 60. Rear Brake. A- holes, 1- bolts, 2- brake drum

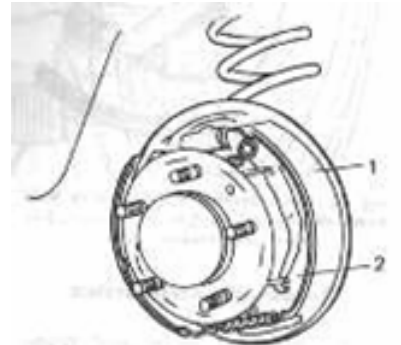

Fig 61. Rear brake with drum removed. 1- friction lining, 2- brake shoe

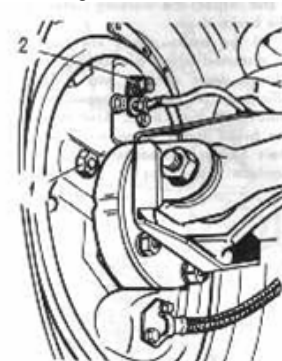

Fig 62. Brake backing plate viewed from rear axle. 1- adjusting eccentric head, 2- rear brake bleeder valve.

Bleeding the Brake System

An increased travel and sponginess of the brake pedal manifest the presence of air in the brake system which impairs considerably efficiency of the brakes. Evacuate air from the system by bleeding in succession; the brake mechanism cylinders of the R.H. rear wheel, then of the L.H. rear wheel, of the L.H. front wheel and, finally, of the R.H. front wheel through the upper bleeder valves. In this way the first brake circuit will be bled. To repeat the procedure for the second brake circuit, make use of the lower bleeder valves of the front wheel brake mechanisms. It is allowed to start the bleeding procedure from the R.H. or L.H. front wheel.

Do not jack up the car rear to exclude influence of the pressure regulator.

To perform bleeding, proceed as follows:

1. Unscrew the reservoir cap (Fig. 58) and add some fluid up to the normal level.
2. Remove the protective caps from bleeder valves 3 (Fig. 59) and 2 (Fig. 62) and clean the latter of dirt and dust.
3. Fit a rubber hose on the bleeder valve head (the hose is available in the set of car accessories) and dip the hose end into a clean transparent vessel, partly filled with brake fluid.
4. Press the brake pedal sharply 3-5 times with an interval of 2-3 s and, holding the pedal in the pressed down position, give the bleeder valve $\frac{1}{2}$ - $\frac{3}{4}$ 01 a turn out and keep pressing down the brake pedal to force out the brake fluid together with air into the vessel. When the brake pedal rests against the stop and escape of the brake fluid ceases, screw in the bleeder valve. Repeat this operation until air bubbles cease to escape from the hose.
5. Keeping the brake pedal de-pressed, screw the bleeder valve all the way in and remove the hose. Wipe the bleeder valve end dry and install the protective cap.

In the process of bleeding see that the fluid level in the reservoir is sufficient. The bleeding over, restore the required maximum fluid level in the reservoir. The fluid discharged from the brake system during the bleeding should not be reused.

Pressure Regulator

Every 30.000 Km check the pressure regulator for serviceability, for which purpose:

- Place the car on a lift or an inspection pit;
- Clean the regulator and its boot from dirt;
- Carefully remove the boot, wipe off the remaining grease, and clean the torsion lever-to-regulator piston joint;
- Ask an assistant to sharply depress the brake pedal. With the pressure regulator serviceable, the protruding portion of the piston will move relative to the body, thus twisting the torsion lever.
- Repeat the operation two or three times and, having made sure that the pressure regulator is serviceable, pack 5-6 g of fresh grease P~T-1 into the regulator, and put on the boot.
- If the piston does not move relative to the body, apply to a service station.

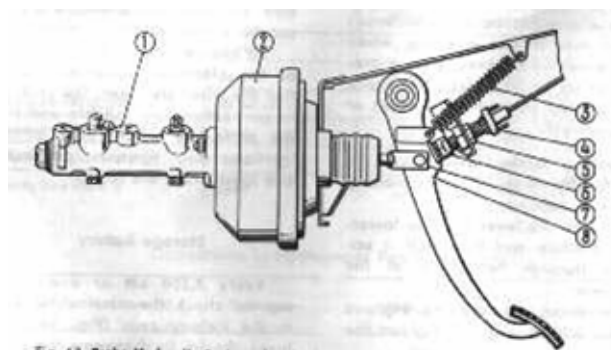

Fig 63. Brake hydraulic system. 1- brake master cylinder, 2- vacuum booster, 3- pedal pull-back spring, 4- stop light switch, 5- thrust screw nut, 6- stop light switch buffer, 7- pushrod, 8- brake pedal.

Adjusting the Free Travel of Brake Pedal

Every 20.000 Km (and also after the first 2,000-3,000 Km if the car is new), check and adjust, if necessary, the brake pedal free travel. With the brake system serviceable and the shoe-to-drum clearances of the rear wheels normal, the brake pedal free travel, with the engine shut down, should be 3-5 mm. Adjust free travel by shifting stop- light switch 4 (Fig. 63) together with buffer 6 after unscrewing nut 5. Adjustment over, tighten nut 5.

Brake Vacuum Booster

Every 30.000 Km check the vacuum booster for serviceability in the following manner: depress the brake pedal 5-6 times, with the engine shut down, and holding the brake pedal pressed, start the engine. With the vacuum booster serviceable, the brake pedal should move further down upon starting the engine. If the pedal does not move further down, check for tightness the hose connections to the intake manifold and to the vacuum booster, as loose connections cause in leakage of air and sharply reduce vacuum booster efficiency. If the trouble persists apply to a service station.

Parking Brake

Every 20,000 Km (and also after the first 2,000-3,000 Km if the car is new) adjust the parking brake.

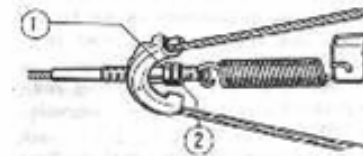

Fig 64. Adjusting parking brake lever travel. 1- adjusting nut, 2- locknut

Correct adjustment of the parking brake ensures reliable operation of the whole brake system of the car. Perform adjustment of the parking brake after adjustment of clearances in the rear brakes and also when the car cannot be braked on a gradient of up to 30 % with the brake lever shifted through 4-5 teeth of the quadrant.

Parking brake lever travel is adjusted by means of the tensioning device as follows:

- Shift the lever into the lower- most position and then pull it upwards through two teeth of the quadrant;
- Loosen locknut 2 (Fig. 64), and turning adjusting nut 1, tighten the cable;
- Tighten locknut 2 and check that the car remains braked after shifting the lever through 4-5 teeth of the quadrant.

To prevent shoe-to-drum freezing after travelling over wet roads at sharp fluctuations of ambient temperature, do not apply the parking brake when leaving the car in a parking lot or a non-heated garage, unless the brakes are dried by applying them smoothly while driving to the parking area.

ELECTRICAL EQUIPMENT

The car wiring diagram is shown in Fig. 65. Do not tamper with the car electric circuits. Additional power consumers should be connected only by qualified electricians at a service station. To ensure trouble-free operation of the electrical equipment check that the wires are clean, the contacts in connections are reliable and that the protective rubber caps on the ignition coil, ignition distributor and spark plugs are sound.

Wiring diagram

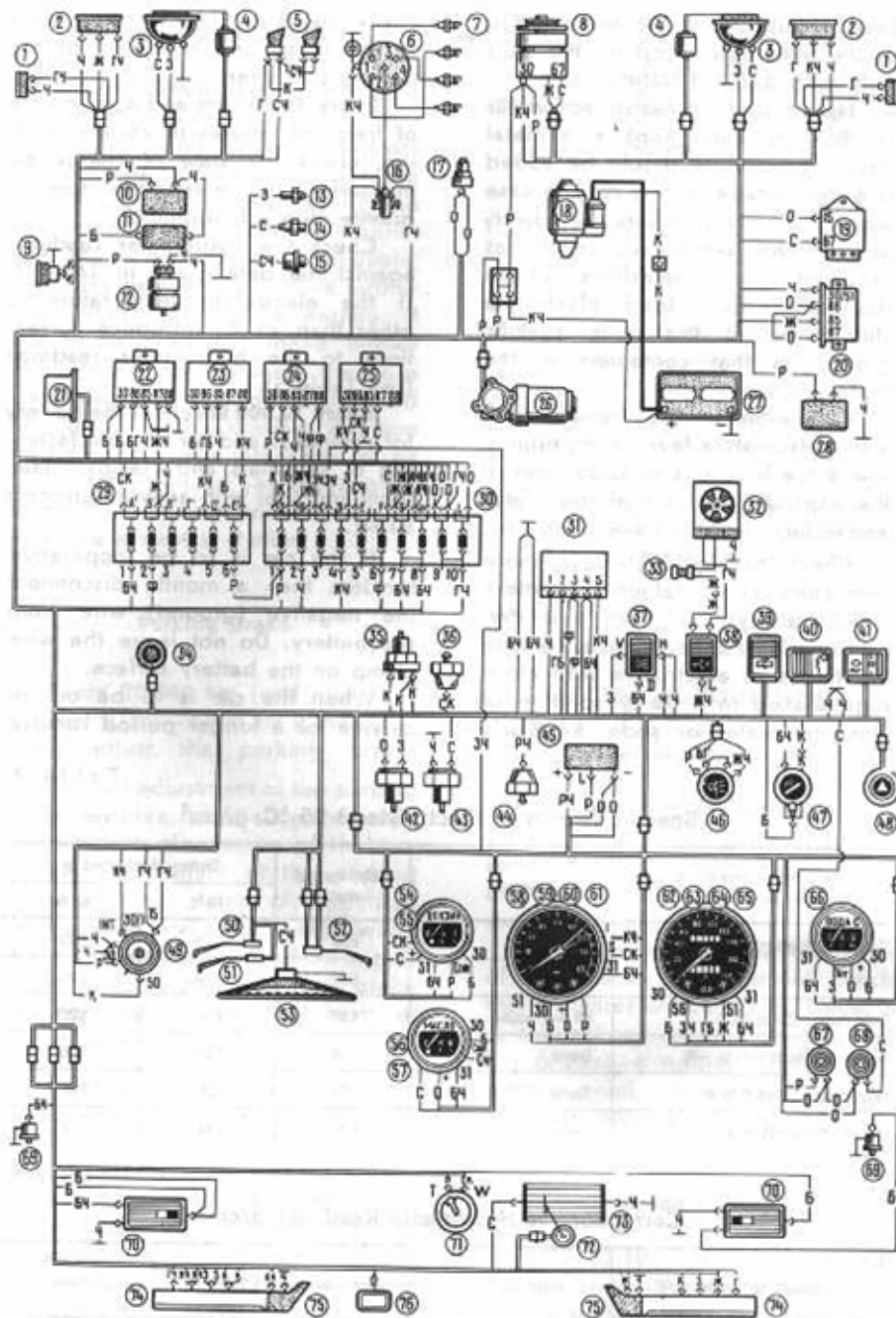

Fig. 65. Wiring Diagram: 1- ride direction indication; 2- ride lights; 3- headlight; 4 head- light wiper motor; 5- horn; 6- ignition distributor; 7- spark plugs; 8- alternator, 9- Inspection lamp socket; 10- windshield wiper pump; (1- headlight washer pump; (1-k~ fluid level transmitter; 13- coolant temperature transmitter; 14- low oil pressure warning lamp transmitter; 15- oil pressure gauge transmitter; (6- ignition coil; 17- idling electromagnetic valve; 18- starter; 19- voltage regulator; 20- battery no-charge warning lamp relay 21- windshield wiper relay; 22- headlight wiper relay; 23-headlight upper beam relay; 24- headlight lower beam relay; 25- back window hooter relay; 261 windshield wiper P1- storage battery; 28- back window wiper pump; 19- additional furs block; 30-main fuse block; 31- emergency flasher system and direction indicator (lather unit; 32-aatk) tan; 33- heater fan series resistor; 34- instrument lighting Switch; 35- stop-light switch: 1~ choke warning lamp switch; 37- external lighting switch; 38- heater fan switch; 39-blcL window wiper and washer switch; 40- back window heater switch; 41- rear fog lamp (witch; 42- backing light switch; 43- transfer differential lock warning lamp switch; 44- parking brake warning lamp switch; 45- parking brake warning lamp flasher unit; 46- headlight wiper twitch; 47- cigarette lighter with illumination lamp; 41- emergency flasher system switch and warning lamp; 49- ignition switch; 50- headlight switch; 51- direction indicator switch; 52- wind- shield wiper and washer switch; 53- horn button; 14- fuel level gauge; 55- low fuel warning lamp; 56- oil pressure gauge; 57- low oil pressure lamp; 58- tachometer; 59- par- king brake warning lamp; 60- battery no-charge warning lamp; 61- choke warning lamp; 62- speedometer; 63- marker light warning lamp; 64- direction indicator warning lamp; 65-headlight upper beam warning lamp; 6~cool-n~ temperature gauge; 67-lantlor differential lock warning lamp; 68- brake fluid low level warning lamp; 69- interior lamp door switches; 70- interior lamps and switches; 71- fuel level and low fuel transmitter; 72-brit window wiper; 73- back window heater; 74- tail light; 75- number plate lamps: 76-fog lamp

Wire Colour Code: P- pink; 3- green; Trl blue with black tracer; T- blue; 6-whih; 0- amber; m- yellow; C- grey; K~- brown; ~- black; K- red; 6~- white with black tracer; mCl-yellow with black tracer; CLl-green with black tracer; 3Lt- green with black tracer; r6- blue with white tracer; CK-grey with rod tracer; TK- blue with red tracer; 0-, violet; p-i- pink with black tracer; 61- white with blue tracer

Storage Battery

Every 2,500 Km or every four months check the electrolyte level in the battery cells (Fig. 66). The level should be between the MIN and MAX marks on the semi-transparent battery case; otherwise the level should reach the lower edge of the filler holes. Top up the cells only with distilled water.

Never add non-distilled water or distilled water kept in a metal vessel. Electrolyte should be added into the storage battery only in case when it is known for sure that lowering of the electrolyte level has occurred due to splashing out. In this case, the added electrolyte should be of the same specific gravity as that contained in the battery.

Operation of the battery with a low electrolyte level is impermissible since it results in sulphation of the exposed portions of the plates and reduction of the battery capacity.

Check the electrolyte level more frequently in hot weather. The battery should always be clean and dry, particularly its upper surface. Remove the traces of electrolyte with clean rags soaked in a 10 % solution of ammonia water or soda. Regularly check cleanness of the vent holes in the plugs and condition of the battery container.

Every 10,000 Km and also in case of frequent failures in engine starting, check the state of charge by measuring the electrolyte specific gravity with a hydrometer.

Check the hydrometer readings against the data given in Table 4. (*Not included yet*) If the electrolyte temperature is other than 25°C, introduce corrections to the hydrometer readings (see Table 5).

Every 20,000 Km check the battery for cleanness and for reliable fastening of terminals and clamps; clean them and coat with aerosol lubricant BTB-1.

If the car is to be inoperative for less than a month, disconnect the negative (ground) wire from the battery. Do not leave the wire clamp on the battery surface. When the car is to be out of service for a longer period remove the battery from the car, fully charge it and keep it, whenever possible, in a dry cool room at a temperature not above 0°C. The minimum storage temperature should not be below minus 50 °C.

Never store the discharged battery since this will lead to sulphation of plates, and finally, to a complete failure of the battery. Therefore, be sure to check the battery specific gravity every month, charging it whenever necessary.

Alternator

Every 10.000 Km carefully dress the alternator slip rings with glass cloth, check the brushes for wear and seating and replace them if necessary. The brushes should move easily in the holders and should have no chippings. When the car is driven constantly on dusty and dirty roads perform this operation more frequently.

Starter

Every 40.000 Km carefully dress the commutator, check the brushes for wear and seating and, whenever necessary, replace them with new ones, having them bedded properly to the commutator.

At the same time be sure to clean and lubricate the helical splines of the starter shaft, the bushings of both end shields and the drive pinion with engine oil, and the pinion shift ring of the starter drive, with grease.



Fig 66. Holes for checking electrolyte level in storage battery cells

Voltage Regulator

Any servicing of the voltage regulator must be performed by qualified specialists only. When installing the voltage regulator on the car or removing it from the car, see to it that the regulator is not subject to blows which may bring it out of adjustment.

Aiming the Headlight Lower Beam

Every 20.000 Km (end also after the first 2,000-3,000 Km if the car is new) aim the headlights. The car is equipped with head lights that have an asymmetric light distribution of the lower beam, with a sharp boundary between the light and dark zones; such light distribution makes it possible, with the headlight aimed properly, to reduce the dazzling effect on the drivers of the oncoming vehicles.

To aim the headlight lower beam proceed as follows:

1. Place the car in running order with a load of 750 n (75 kg) on the driver's seat and with normally inflated tyres on a level ground (Fig. 67) at a distance of 5 m from a vertical white screen located in a shade. A white wall of a building may serve as a screen.
2. Rock the car sideways to stabilise the car suspensions.
3. Draw on the screen axial line O located in the car symmetry plane. Symmetrically to the axial line, draw lines A and B (a distance of 1160 mm between them should correspond to the distance between the headlight centres). Then draw horizontal line 1 at height h (which is a distance from the headlight centre to the ground), and line 2 which should be 120 mm below line 1.
4. Switch on the lower beam and rotating screws 1 and 2 (Fig. 68), set the light units so that the horizontal border-line between the light and dark zones passes along line 2 (Fig. 67), and the inclined limiting lines come from the points of intersection of lines A and B with line 2.

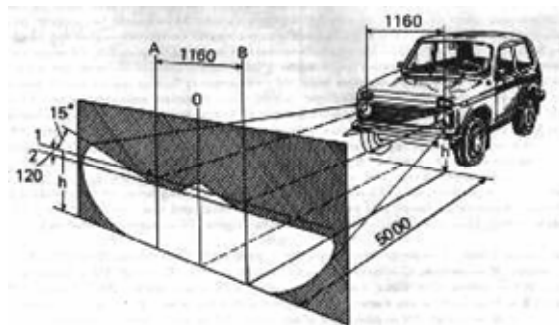

Fig 67. Aiming headlight lower beam

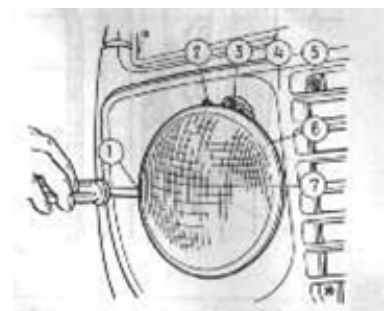

Fig 68. Headlight. 1- horizontal adjustment screw, 2- vertical adjustment screw, 3- headlight rim screw, 4- radiator decorative grille, 5- radiator grille screw, 6- headlight rim, 7- light unit

Replacing the Bulbs

To replace a bulb in the headlight, turn out screws 5 (Fig. 68) which secure decorative grille 4 of the radiator and remove the grille; loosen screws 3 securing the light unit rim, turn the rim counter-clockwise and remove it. Take out light unit 7 and throw off the bulb spring clamps.

To replace the bulb in the side light or in the rear fog lamp turn out the lens fastening screws, remove the lens, gently press on the bulb, turn it counter-clockwise, and take it out.

A burnt-out bulb in the side direction indicator should be replaced after removing the socket with the bulb on the engine compartment side.

Tail lights

To replace the bulb in the tail light turn off the upper screws which secure the luggage compartment lining, screw off nut 2 (Fig. 69) and remove lens 3.

To replace the bulb in number plate lamp 9, disconnect connector 1 and remove the holder with the bulb.

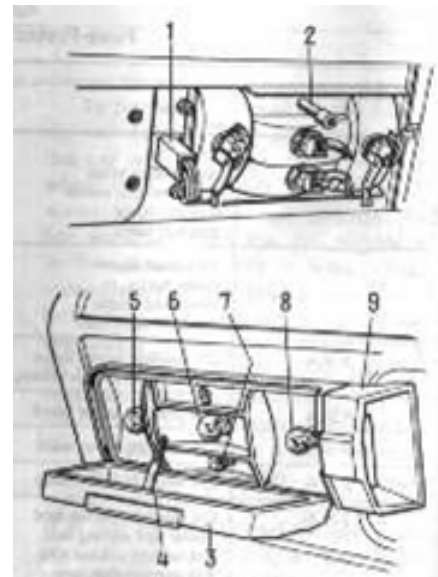

Fig 69. Tail light and number plate lamps. 1- connector, 2- nut, 3- lens, 4-pin, 5- direction indicator bulb, 6- reverse light bulb, 6- marker light bulb, 8- stop light bulb, 9- number plate lamp.

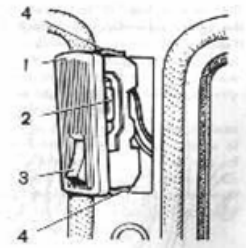

Fig 70. Interior lamp. 1- lens, 2- bulb, 3- switch, 4 fastening spring.

To replace the bulb in the body interior lamp. Carefully pull it out. The lamp is kept in the recess of the centre pillar by two springs 4 (Fig. 70).

Fuses

Fuses are installed in two blocks. The first block contains a 16 A fuse (Fig. 71) and nine 8 A fuses. The second block contains four 8 A fuses and two 16 A fuses.

Fuses are held in the blocks by spring contacts. The circuits protected by fuses are listed in Table 6.

The electric circuits of ignition, engine starting, alternator (except for the field winding), headlight lower beam relay and headlight upper beam relay are not protected by fuses.

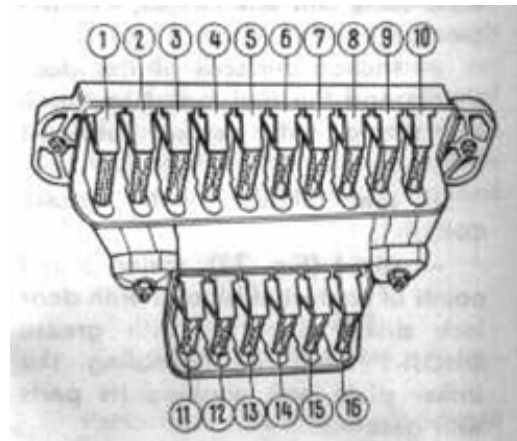

Prior to replacement of a blown- out fuse, find out and eliminate the cause of trouble.

Fuse-Protected Circuits

Fuse No amperage in Fig 71	Protected circuit	Fuse No amperage in Fig 71	Protected circuit
1 (16 A)	Horns Body interior lamps Inspection lamp socket Cigarette lighter step-light bulbs	2 (8 A)	Windshield wiper Heater fan Windshield washer Headlight wiper relay
		3 (8 A)	LH headlight (upper beam) Headlight upper beam warning lamp

4 (8 A)	RH headlight (upper beam)	10 (8 A)	Voltage regulator
5 (8 A)	LH headlight (lower beam)		Alternator field winding
8 (8 A)	RH headlight (lower beam)	11 (8 A)	Rear fog lamp
7 (8 A)	LH side light (marker light)	12 (8 A)	Electric motors of headlight wipers and washer
	Marker light warning lamp	13(8A)	Back window wiper and washer
	RH tail-light (marker light)	14 (16 A)	Back window heater (power circuit)
	RH member plate lamp	15 (16 A)	Reserve fuse
8 (8 A)	Instrument lighting lamps	16 (8 A)	Emergency flasher system switch end direction indicators operating in emergency mode
	RH side light (marker light)		
	LH tail-light (marker light)		
	Cigarette lighter illumination lamp		
9 (8 A)	LH number plate lamp		
	Oil pressure gauge		
	Low oil pressure warning lamp		
	Fuel level gauge and low fuel warning lamp		
	Coolant temperature gauge		
	Direction indicators with warning lamp		
	Backing light lamps		
	Parking brake warning lamp		
	Brake Fluid low level warning lamp		
	Differential lock warning lamp		
	Battery no-charge warning lamp		
	Choke warning lamp		
	Tachometer		
Carburettor electromagnetic valve			
Flasher unit of parking brake warning lamp			
Direction indicator flasher unit			
Back window heater (control circuit)			

BODY

Care of Body

To preserve the attractive appearance of the car give constant attention to the car body surfaces. To prevent scratches on the body do not remove dirt and dust from the car with dry rags. Wash the car when mud is still wet, using a weak water spray and a soft sponge. In hot weather wash the car outdoors in the shade. If this is impossible, immediately wipe the washed surfaces dry, since drops of water that dry under the sun rays leave stains on the body painted surface. At sub- zero ambient temperatures, having washed the car in a warm room, wipe the body dry before a trip because frozen drops of water may cause cracks on the body paint coating. It is not recommended to use soda and alkaline solutions, as they may tarnish the paint coating.

When using a hose for washing, see that water does not get on the electric units in the engine compartment.

Minor chipping of paint on the car body should be timely sanded and coated with the paint contained in the tin furnished with the car.

In case corrosion of the car body parts is detected (corrosion traces, local paint blisters, etc.), take necessary measures to eliminate corrosion and prevent its further spreading.

To facilitate examination of boxed spaces of the front fenders, the shields with weatherstrips are made detachable.

To retain lustre of the body paint- work, particularly of the cars kept outdoors, regularly polish the paint coating with the use of polishing pastes or wax compounds.

To ensure prolonged shining of the body surfaces, do not leave the car under the sun rays for a long period of time; prevent acids, soda solutions, brake fluid and gasoline from getting on the painted surfaces.

To prevent stains on the paint coating under the fuel tank access flap caused by spilled gasoline, wipe the surface with clean dry rags before and after the fuel servicing.

In the course of operation the car underbody coating is attacked by gravel, sand and salt. As a result, the anticorrosion compound and primer come off, and the exposed metal gets corroded. **Therefore regularly check the condition of the car underbody coating and timely recondition the damaged areas.**

Clean the chrome-plated parts with soft rags and petrolatum. Wipe the plastic parts with wet rags. It is not recommended to use gasoline or solvents; otherwise, the plastic parts will be tarnished.

Use soft linen rags or chamois leather to clean the glasses. To clean heavily soiled glasses first wash them with water solution of HMMCC-1 liquid or Glass Autocleanser-2 (30 cm³ per litre of water).

Never use gasoline or solvents to clean the body interior upholstery made of artificial leather. Use neutral soap with water for the purpose, then wipe the surfaces dry with soft rags or chamois leather. Simultaneously thoroughly wipe with wet rags the rubber weatherstrips and the door parts in contact with them.

Periodically, depending on the specific conditions of the operation (very cold climate, dusty roads, atmospheric effects during long parking periods), lubricate the following parts and units: - door lock keyholes;

(a) in hot weather with graphite powder;

(b) in cold weather, particularly after washing, with aerosol lubricant BTB-1: as a preliminary, dry the lock keyholes with compressed air;

Door hinges, hood lock re- lease cable and seat hinges, with engine oil; friction surfaces of the door checks and the fuel tank flap hinge and spring, with aerosol lubricant BTB-1; - seat slides, with grease cDMOn-1 ; pin 4 (Fig. 72), spring 5 and points of contact of block 2 with door lock striker plate 1, with grease cDMOn-1 after disassembling the striker plate and washing its parts with gasoline.

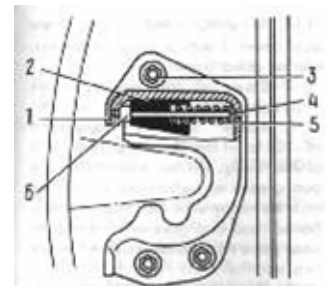

Fig 72. Door lock striker plate. 1- striker plate, 2- block, 3, bolt, 4- pin, 5- spring, 6 bushing.

The car body doors should open and close easily. If the door closes with difficulty or loosely, adjust the position of the door lock striker plate. Prior to beginning the adjustment, outline the position of striker plate 1 on the car body pillar with a pencil. If the door is hard to close, loosen bolts 3, move the striker plate outward and tighten the bolts. If the door closes loosely, move the striker plate inward. If the door sags in closing, raise the striker plate, and on the contrary, lower it, if the door rises. If, for some reason or other, the door lock has been disassembled, wash it to remove old grease and, prior to assembly, lubricate it with grease. It is not recommended to use other grades of grease because at low temperatures the lock may fail to operate, or the door may get spontaneously opened in motion.

Windshield and Headlight Washers

Periodically clean the windshield and headlight washer nozzles and also check the direction of the washing spray which should be aimed at the upper zone of the sector swept by the wiper blade. Adjust the direction of the spray by turning the nozzle with the fastening screw loosened. Adjustment over, tighten the screw. In hot weather the washer reservoir may be filled with clean water, while in cold weather, at an ambient temperature down to minus 25°C, only with a mixture of the HMMCC-4 fluid or Glass Autocleanser-2 (25-33 %) and water.

Windshield and Headlight Wipers

In winter, prior to switching on the wipers, make sure that the wiper blades are not frozen to the glass. Failure to observe this recommendation may lead not only to breakage of the blades, but also to failure of their electric drives.

Fastening of Units and Mechanisms to Car Body

Every 20,000 Km (and also after the first 2,000-3,000 Km if the car is new) check and, if necessary, tighten the fastenings of various units and mechanisms to the car body.

MAINTENANCE IN LONG-TERM STORAGE

The best method is to store the car in a dry, dark and well-ventilated room at a temperature of not below 5 °C and a relative humidity of 50- 70 %. In this case the storage battery and the car radio may be left in the car.

When the car is stored in a cold room, remove the storage battery and the radio and keep them separately; drain fluid from the washer tank. If the cooling system is filled with water, drain it.

When storing the car in a room lighted by sun rays protect the car body and tyres with a cover made of moisture-permeable material. The employment of covers made of water-proof materials (canvas, plastic film, and the like) having no vent holes within the zone of the windshield and back window leads to condensation of moisture on the body surface; prolonged action of moisture on the body paintwork may ruin it.

If the car is kept outdoors under a cover, the cover should not contact the body painted surfaces, otherwise the paint coating may be damaged (blisters, peeling, etc.). To provide normal ventilation, place soft spacers, at least 20 mm high, between the cover and the body.

When preparing the car for long-term storage, proceed as follows:

1. Wash the car and wipe its body dry. Remove traces of corrosion. Touch up damaged painted surfaces. Apply a wax compound to the body and polish the latter.
 2. Start the engine and warm it up. Turn out the spark plugs and pour 25-30 g of engine oil heated to 70-80°C into each cylinder. To spread the oil uniformly on the entire surface of the cylinders, give the crankshaft 10-15 revolutions with a starting crank, and screw in the spark plugs.
 3. Use an oiled tape (paper or fabric) to seal the following holes: - in the air intake pipe of the air cleaner housing; in the muffler tail pipe; in the fuel tank vent pipe.
 4. Reduce the tension of the alternator drive belt.
 5. Grease-gun the propeller shaft splined joints and crosses.
 6. To protect the engine from dust cover it with a piece of canvas, film or oiled paper.
 7. Clean all the electric wires of dirt and wipe them dry.
 8. Apply slushing compound HT-208 to all the chrome-plated parts of the body. As an equivalent use gun grease or petrolatum (the latter must be renewed every four months). Do not use cup grease for this purpose since it has to be renewed every two months.
-

9. Place the car on four supports so that the wheels are clear of the ground. Position the supports under the brackets located near the sockets for the jack arm. Deflate the tyres to 0.05 MPa (0.5 kgf/cm²).
10. Check the driver's tools for missing items, coat them with a slushing compound and wrap in oiled paper.
11. Put the cover on the car.

Maintenance of the car in storage (once every two months) consists in the following:

- Take off the cover and examine the car. Clean and touch up the corroded areas on the painted surface; clean off any corrosion from the chrome-plated surfaces and coat them with nitrocellulose varnish.
 - Screw out the spark plugs, shift into the 1st gear, give the crank- shaft 10-15 revolutions with the starting crank and screw the spark plugs back in place.
 - Give the steering wheel 1-1.5 revolutions either direction. Operate the brake and clutch pedals, accelerator pedal, parking brake handle and choke control knob 3-5 times.
-